

# DENAFRIPS

## PONTUS II DAC

OWNER'S MANUAL

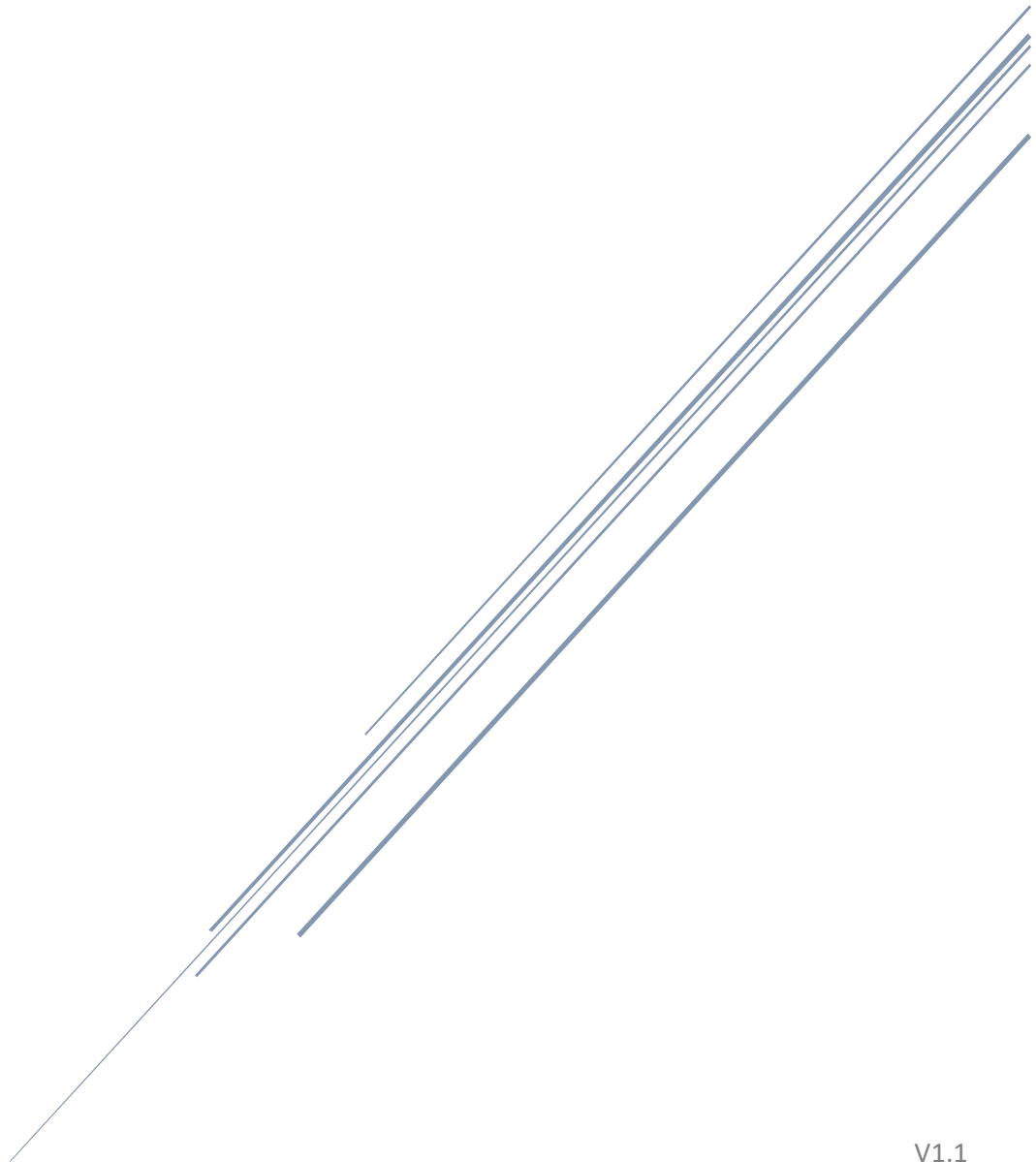

V1.1  
16th May 2021

## Contents

1. INSTALLATION & SAFETY INSTRUCTIONS .....	2
2. INTRODUCTION .....	3
3. DESIGN HIGHLIGHTS .....	4
3.1 ADAPTIVE FIFO BUFFER RECLOCKING .....	4
3.2 I2S INPUT .....	4
3.3 PROPRIETARY, STATE-OF-THE-ART USB INTERFACE .....	4
3.4 PROPRIETARY SPDIF DIGITAL AUDIO RECEIVER .....	4
3.5 NOS/OS .....	5
3.6 PROPRIETARY R-2R AND DSD DECODING ARCHITECTURE .....	5
3.7 DAC ARCHITECTURE .....	6
4. OPERATING INSTRUCTION .....	7
4.1 Quick Start Guide .....	7
4.2 USB DRIVER INSTALLATION – WINDOWS OS .....	12
5. SPECIFICATIONS .....	16
6. WARRANTY .....	17

## 1. INSTALLATION & SAFETY INSTRUCTIONS

This DAC is designed and built to provide trouble-free performance, but as with all electronic devices it is necessary to observe a few precautions:

- Unpack the DAC carefully.
- Position the DAC on a stable, horizontal surface, i.e. sturdy rack.
- The DAC supports voltage 100-250VAC worldwide voltage. Please connect the AC power cord with earth(ground) pin unless it is absolutely required to reduce hum from the ground loops of the connected devices.
- Always ensure that when disconnecting and reconnecting your audio equipment the mains supply is turned off.
- Position the power cord and signal interconnects where they are not likely cause trip and fall hazard.
- Do not use the DAC near water, or place water-filled containers on the DAC. Entry of liquid into the DAC is hazardous and may cause electric shock and/or fire hazard.
- Do not place the unit under direct sunlight or heat source.
- Do not remove any covers or try to gain access to the inside. There are no user adjustments or fuses to change without qualification.
- Clean regularly with a damp soft cloth. Do not use any cleaning agents as it might damage the surface finishing.
- The electronics in modern hi-fi equipment is complex and may, therefore, be adversely affected or damaged by lightning. For protection of the audio system during electrical storms, disconnect the mains plugs.

## 2. INTRODUCTION

Thank you for purchasing the DENAFRIPS PONTUS DAC.

The Pontus DAC is a true balance R-2R DAC. Each channel is equipped with independent high-speed FPGA to facilitate the D/A conversion by 4 sets of 0.01% R-2R arrays. This design has small linear error, high decoding speed, low digital noise, not only to ensure that the audio signal is low distortion, but also to ensure a very low background noise; allow listener to enjoy the true music with quiet background.

We are confident Pontus sound quality far exceed its modest price tag.



## 3. DESIGN HIGHLIGHTS

### 3.1 ADAPTIVE FIFO BUFFER RECLOCKING

The DENAFRIPS approach to address the jitters issue by FIFO BUFFER RECLOCKING. The adaptive FIFO buffer store the source digital audio data in the memory. These data are read from the memory using the low phase noise, precision FEMTO Clock, located right in the DAC.

This technology is close to the perfection, especially so with the local FEMTO Clock. The jitter is so small that it can be neglected.

### 3.2 I2S INPUT

PONTUS comes with a LVDS I2S input over the HDMI connector. Despite the I2S input has no industrial standard, it is probably the best digital input interface to-date. *NOTE:* DENAFRIPS cannot guarantee the compatibility with other I2S devices.

### 3.3 PROPRIETARY, STATE-OF-THE-ART USB INTERFACE

The PONTUS is equipped with the proprietary USB Audio Solution, powered by STM32F446 Advanced AMR Based MCU. DENAFRIPS redesigned and optimized circuitry, allow the DAC to be used as high-end DAC with computers / streamers. It supports 24bit/1536kHz\* PCM data stream, and native decoding of DSD up to DSD1024\*. It comes with licensed THESYCON USB Driver for Windows Platform.

*NOTE:* The USB Module is designed to trigger on *only* when USB Input is selected. This is intended design to reduce digital input interfaces cross-interference for best sound reproduction. \*High-res support may vary depending on system compatibility.

### 3.4 PROPRIETARY SPDIF DIGITAL AUDIO RECEIVER

The SPDIF Coaxial, Optical, AES/EBU input support up to 24bit/192kHz digital audio format. The PONTUS abandon the use of Digital Audio Receiver chip. The digital data is decoded by the on-board FPGA (Field Programmable Gate Array), signal path is shortened and eliminated the undesirable coloration.

## 3.5 NOS/OS

The PONTUS allow the user to change the sampling mode on the fly.

NOS, as the name suggested, does not over-sampling to digital input data.

In OS mode, the PCM 44.1kHz or 48kHz based audio data are up-sampled to the maximum rate of PCM1411.2 or PCM1536. There is no up-sampling of DSD audio signal.

## 3.6 PROPRIETARY R-2R AND DSD DECODING ARCHITECTURE

The PONTUS is equipped with 24Bit R-2R DAC to decode PCM data stream and 32 steps FIR analogue filters hardware decoder to decode DSD data stream. These designs guaranteed the PCM format can be perfectly decoded, at the same time, the DSD format can be perfectly decoded as well. It is rare in the currently market that a R-2R DAC can hardware decode both the PCM and DSD formats.

## 3.7 DAC ARCHITECTURE

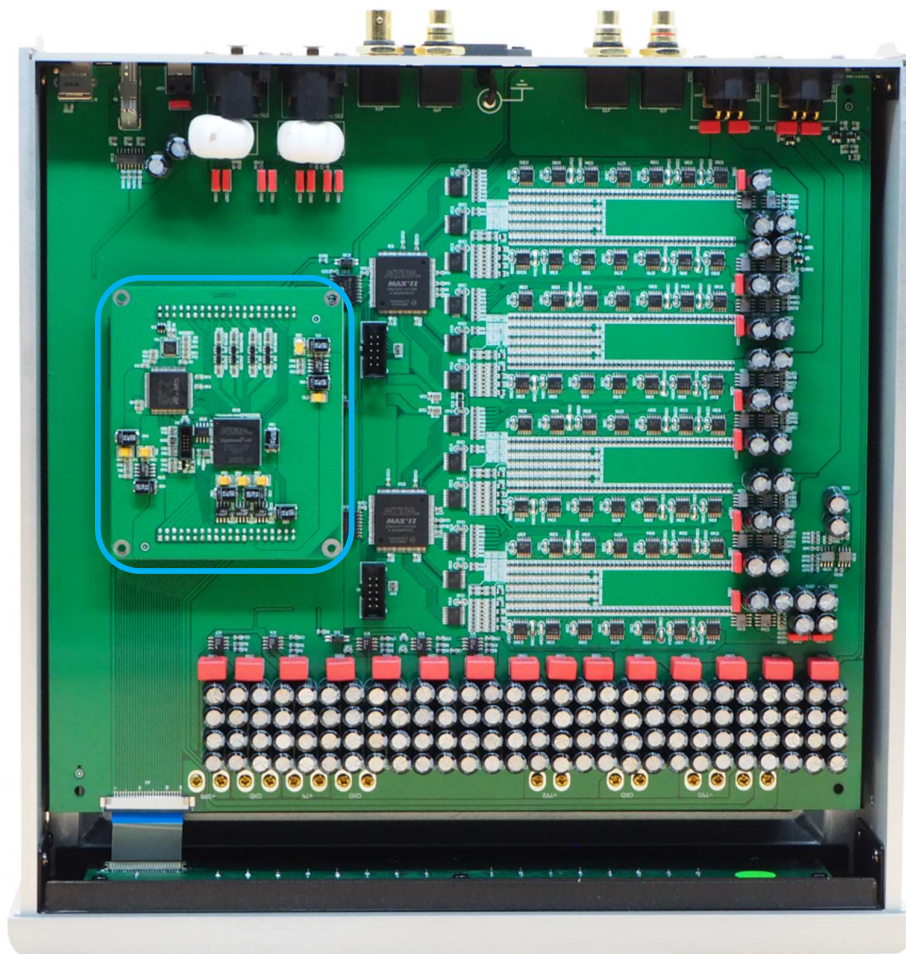

**DIGITAL SIGNAL PROCESSING** – All digital input data are stored in the on-board FPGA high-speed RAM.

**FEMTO CLOCK** – These data are read from the memory using the low phase noise, accurate FEMTO Clock, located right in the DAC. The processed data are sent to the final stage Discrete R-2R for DA conversion.

**R-2R LADDER NETWORK** – The data bits are converted to analogue signal by the true balanced R-2R ladder network arrays. The linearity of the conversion is guaranteed by the high-precision thin film resistors, with low thermal effect temperature coefficient of the low 10/15ppm.

## 4. OPERATING INSTRUCTION

### 4.1 Quick Start Guide



Figure 1. Front Panel

#### (1) Standby Button

Press the button once to switch on the DAC, vice versa, press once to put the DAC into standby mode. The Standby LED shall be on when the DAC is in Standby Mode. The LED shall be off when the DAC is in Operating Mode.

#### (2) Control Button (From left to right)

##### a. INPUT + / Input - :

Press the buttons to select the input source, namely, CO1, CO2, OPT, AES1, AES2, USB, I2S. Press + to select the next right input. Press – to select the previous left input. The respective input source LED shall be on to indicate that the input source is selected.

##### b. PHASE

Press the button to toggle Phase Output. LED On: Positive Phase, LED Off: Negative Phase

##### c. OS/NOS

Press the button to toggle between OS/NOS model. The LED lit to indicate the DAC is in NOS mode.

##### d. MUTE

Press the button to enable/disable Mute. When mute, the Input Signal LED will be blinking from Left to Right.



### (3) Digital Audio Signal Input Sampling Rate

The following table illustrate the Input Sampling Rate LED status.

Base Sampling Rate	Multiplier	Input Format
44.1 kHz	1X	44.1 kHz
	2X	88.2 kHz
	4X	176.4 kHz
	8X	352.8 kHz
	16X = 2X + 8X	705.6 kHz
	32X = 4X + 8X	1,411.2 kHz
48 kHz	1X	48 kHz
	2X	96 kHz
	4X	192 kHz
	8X	384 kHz
	16X = 2X + 8X	768 kHz
	32X = 4X + 8X	1536 kHz
DSD	1X	DSD 64
	2X	DSD 128
	4X	DSD 256
	8X	DSD 512
	16X = 2X + 8X	DSD 1024

Table 1. Sampling Rate

## Parameter Settings:

### (1) Filter Selection (Effective in OS Only)

1. Press the Mute button once to enter configuration mode
2. Press the Mode momentarily
  - OPT On = Slow Filter
  - OPT Off = Sharp Filter
3. Wait for 10s
4. DAC back in operational mode

### (2) Dual AES/EBU Input

1. Press the Mute button once to enter configuration mode
2. Press the INPUT+ momentarily, CO1, CO2 LED will turn on/off
  - CO1 On = Dual AES/EBU Input Enabled
  - CO2 Off = Dual AES/EBU Input Disabled
3. Wait for 10s
4. DAC back in operational mode

### (3) I<sup>2</sup>S Pinout Configuration

1. Select I<sup>2</sup>S-A Input
2. Press the Mute button once to enter configuration mode
3. Press the Phase button momentarily, 1X 2X 4X will turn on/off in a fixed pattern to denote binary 000-111
  - PSAUDIO I<sup>2</sup>S Standard = 1X On, 2X 4X Off = 100
4. Wait for 10s
5. DAC back in operational mode

## Video Guide:

<https://www.denafrips.com/config-pontus>

## I<sup>2</sup>S Pinout Configuration

MODE	LED			I2S PINOUT							
	1X	2X	4X	PIN	DATA		BCK		LRCK		
	DATA	BCK	LRCK	MODE	1	3	4	6	7	9	
0	0	0	0	0	DATA-	DATA+	BCK+	BCK-	LRCK-	LRCK+	
1	1	0	0	1	DATA+	DATA-	BCK+	BCK-	LRCK-	LRCK+	
2	0	1	0	2	DATA-	DATA+	BCK-	BCK+	LRCK-	LRCK+	
3	1	1	0	3	DATA+	DATA-	BCK-	BCK+	LRCK-	LRCK+	
4	0	0	1	4	DATA-	DATA+	BCK+	BCK-	LRCK+	LRCK-	
5	1	0	1	5	DATA+	DATA-	BCK+	BCK-	LRCK+	LRCK-	
6	0	1	1	6	DATA-	DATA+	BCK-	BCK+	LRCK+	LRCK-	
7	1	1	1	7	DATA+	DATA-	BCK-	BCK+	LRCK+	LRCK-	

Table 1. I2S PINOUT CONFIGURATION

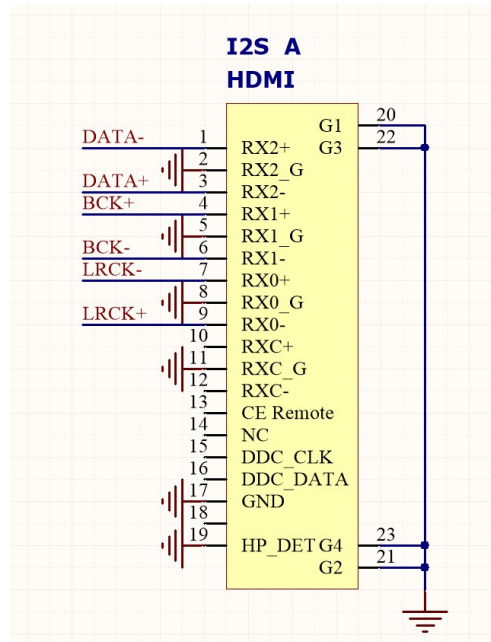

Figure 2. HDMI i2s Input



Figure 3. Read Panel

## Description:

### (1) AC Power Supply

**CAUTION!** PONTUS supports worldwide AC mains, range from 100-250VAC. The Please use a good quality power cord with earth/ground pin connected.

### (2) Analog Audio Signal Output

Balanced output via XLR (pin2 hot), singled ended output via RCA. The PONTUS is a true balanced DAC, we recommend using balanced output whenever possible. The RCA and XLR output are shared, please use either of the output at a time. It is *not* recommended to use both RCA and XLR output simultaneously.

### (3) Digital Input Interface

There are 8 Digital Input Interfaces, namely, CO1, CO2, AES1, AES2, OPT, I2S, USB.

## 4.2 USB DRIVER INSTALLATION – WINDOWS OS

USB driver is required for Windows Operating System (Windows 7/8/8.1/10, X86/X64). The USB driver is licensed by THESYCON to provide the highest quality audio playback for Computer Audio System.

*NOTE: Mac and Linux OS do not require the USB driver.*

### Installation Guide:

- Download the driver from the support page: <https://www.denafrips.com/support>
- Do not connect the USB cable from the computer to the DAC. Remove it before the USB driver installation
- Double click the “DENAFRIPS\_UsbAudio\_v4.82.0” (or the latest version) to install the USB driver.
- Follow the on-screen instruction to complete the installation

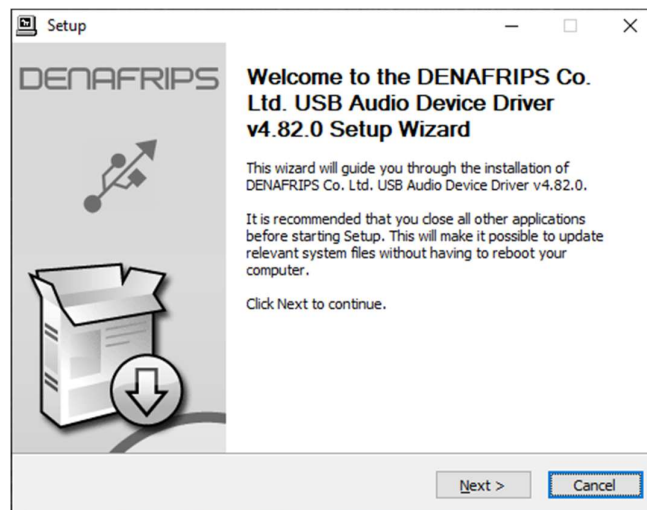

Figure 4. Welcome screen

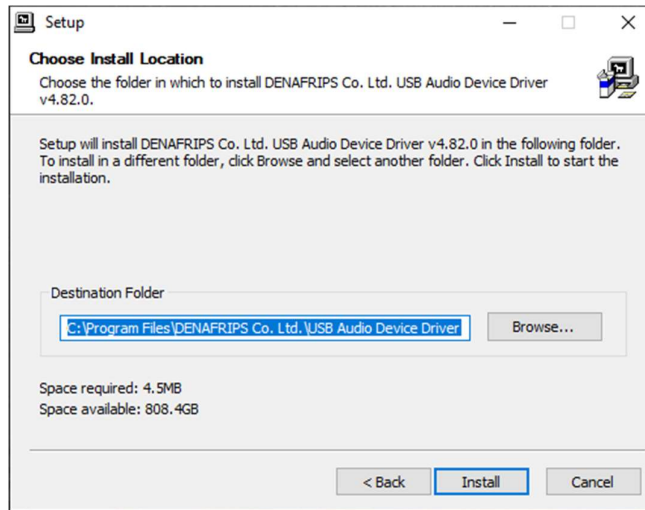

Figure 5. Default Installation Directory

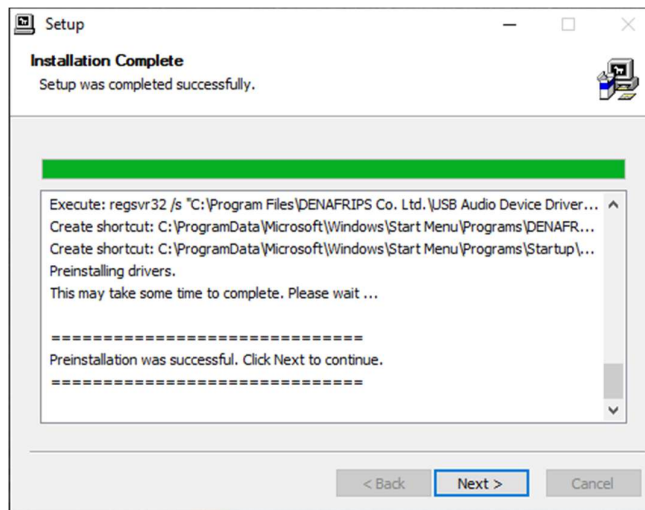

Figure 6. Preinstallation Successful

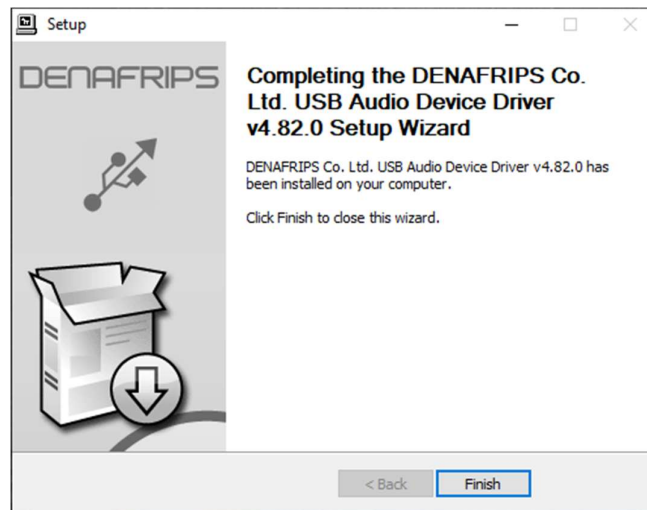

Figure 7. Completed

- Restart the computer to complete the installation
- Connect the USB cable to the DAC
- Power on the DAC. Select USB input
- The USB DAC shall be detected. The driver status can be monitored as follows

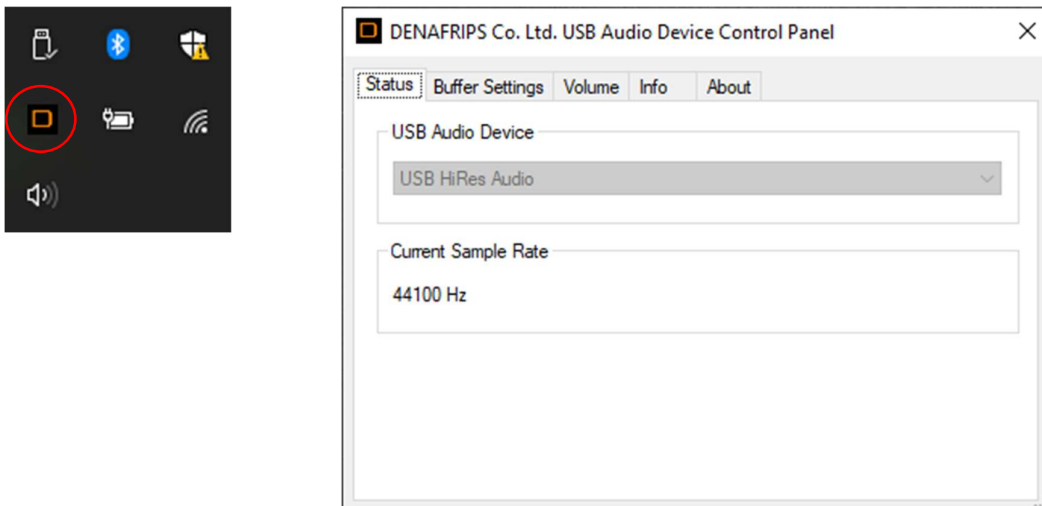
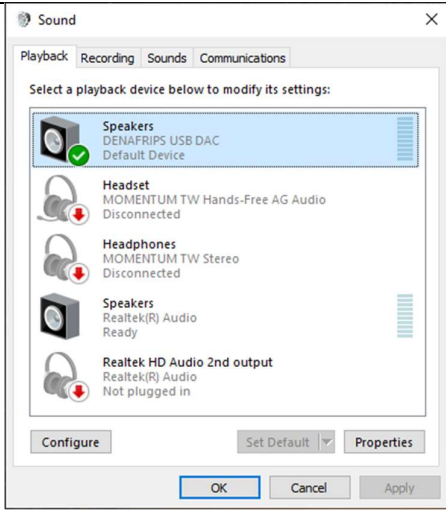
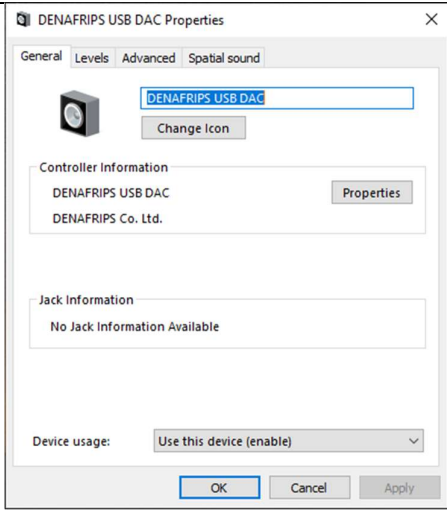
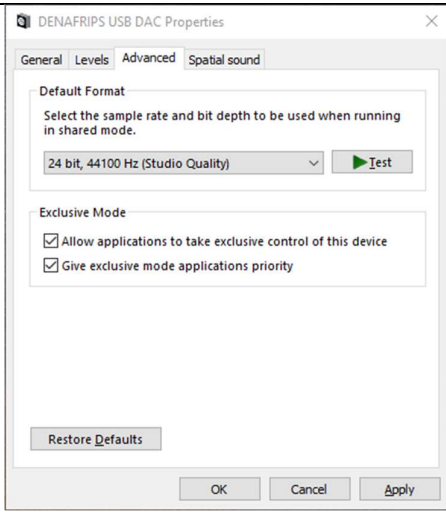
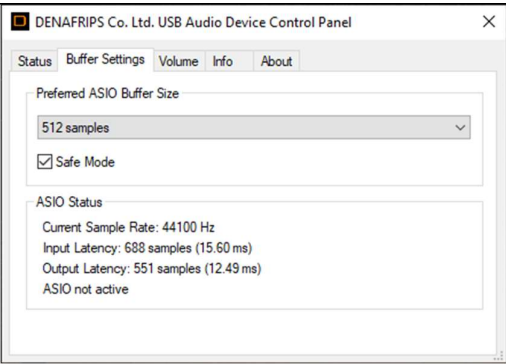

Figure 8. Taskbar & Control Panel

- Select DENAFRIPS USB DAC as default Windows OS Soundcard

	
<p>Press Set Default button</p>	<p>Properties of the DENAFRIPS USB DAC</p>
	
<p>Direct-Sound default format</p>	<p>ASIO Buffer Size</p>

Playback software recommendation:

- roon
- JRiver
- Foobar2000
- Sonicstudio Amarra



## 5. SPECIFICATIONS

Description	Parameters
AC Power	Worldwide AC Power Supported 110 - 230V, 50/60Hz In 110VAC mains, the min voltage ranges from 92V to max 126V In 230VAC mains, the min voltage ranges from 184V to max 253V
Power Consumption	< 30W
Frequency Response	0-70K Hz(-3dB)
THD+N	≤0.0025% (1KHz A Weighted)
Output (RCA)	2.2(+/-10%) V RMS(1KHz)
Output (XLR)	4.4(+/-10%) V RMS(1KHz)
Supported Format (DSD)	DSD64 All Input DSD64 – DSD1024 USB & I <sup>2</sup> S Only
Supported Format (PCM)	24bit/44.1, 48, 88.2, 96, 176.4, 192 kHz All Input 44.1 – 1536 kHz USB & I <sup>2</sup> S Only
S/N Ratio	115dB(RCA), 114dB(XLR)
Dynamic Range	>117dB (RCA), >121dB(XLR)
Stereo Crosstalk	≤-100dB(RCA), ≤100dB(XLR)
Dimension	320 *330 *80 mm
Weight	8.5kg

## 6. WARRANTY

DENAFRIPS PONTUS purchased from the Authorized Distributor comes with 36 months of warranty from the date of purchase / delivery (whichever later).

<b>Defective Within</b>	<b>Warranty Policy</b>
First 30 Days	DENAFRIPS to bear both way shipping fee.
Within 1st Year	Customer to bear one-way shipping fee. DENAFRIPS shall cover the return shipping fee.
Within Warranty Period	Customer to bear both way shipping fee. DENAFRIPS to repair at free of charge.
Out of Warranty	Customer to bear both way shipping cost. DENAFRIPS to provide repair / maintenance services at cost.